

TAB. 1

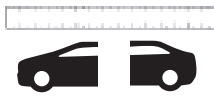

CASA AUTO	MODELLO	PORTE	ANNO
OPEL / VAUXHALL	Astra (G)	4	98>04
OPEL / VAUXHALL	Corsa (B)	3-5	93>00
OPEL / VAUXHALL	Corsa (C)	3-5	00>06
RENAULT	Megane I Station Wagon	5	95>03
SEAT	Córdoba I	4	93>02
SEAT	Ibiza II	3-5	93>02
VOLKSWAGEN	Golf III (1H)	3	91>99
VOLKSWAGEN	Golf III (1H)	5	91>99
VOLKSWAGEN	Vento	4	92>97

M1	M2
5,1	5,1
5,6	4,1
5,6	4,1
3,3	3,3
3,8	3,0
3,5	3,5
4,4	3,3
4,4	3,3
4,4	3,3

G1	F1	G2	F2
31	fissa	31	fissa
31	fissa	31	fissa
31	fissa	31	fissa
31	fissa	31	fissa
31	fissa	31	fissa
31	fissa	31	fissa
31	fissa	31	fissa
31	fissa	31	fissa
31	fissa	31	fissa

T1	T2
X	X
X	X
X	X
X	X
X	X
X	X
X	X
X	X
X	X

X = predisposizione originale



Le tabelle di applicabilità sono soggette ad invecchiamento e/o modifiche, in caso di dubbio si consiglia di consultare il sito www.k39.it costantemente aggiornato.
 The applicability tables are subject to aging and/or changes, in case of doubt it is advisable to consult the constantly updated website www.k39.it.



GUARDA IL VIDEO



WATCH THE VIDEO

1a

4 x

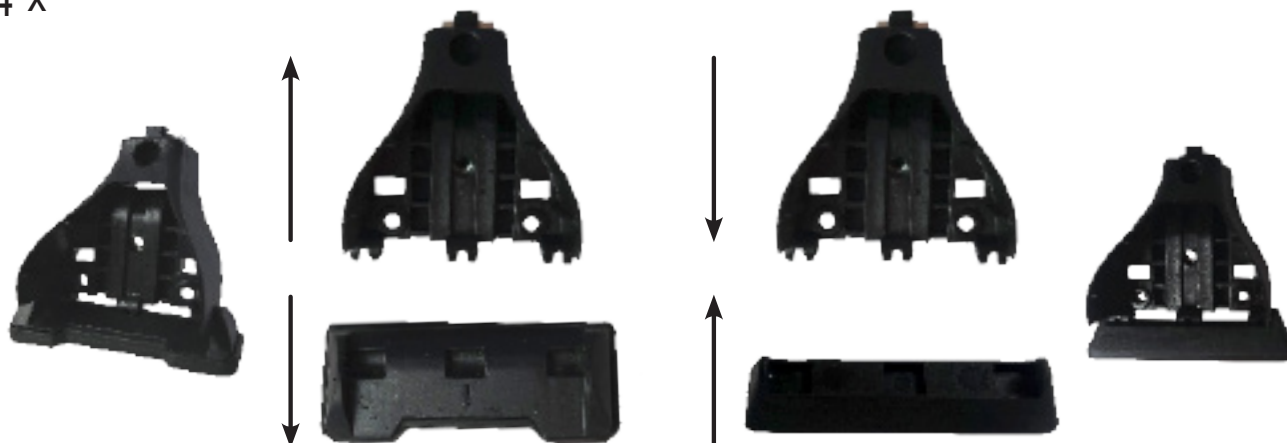

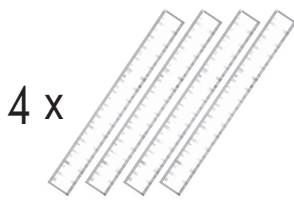
1bTab. 1:
M1
M2

4 x

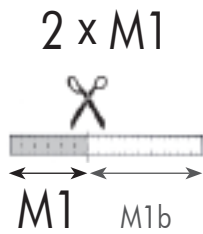

2 x M1

M1 M1b

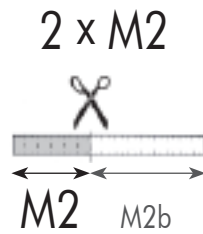

2 x M2

M2 M2b

Tagliare i 4 metri in dotazione alla misura M1 ed M2 riportate in tabella

2

2 x



M1 - M2

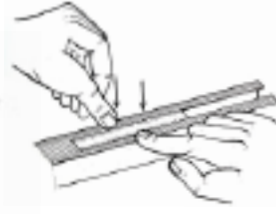
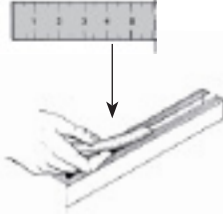

Inserire il metro tagliato in misura M1 nelle 2 cave della barra anteriore, portandolo fine a fine corsa.
Ripetere l'operazione per la barra posteriore con i metri tagliati in misura M2.

3

4 x

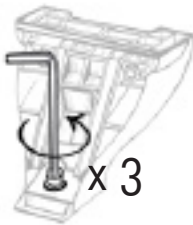

x 3

Prendere i 4 piedi dalla scatola, allentare la vite affinché i piedi possano entrare nella cava.
Prendere il primo piede ed inserirlo in cava facendo **ATTENZIONE** a non sormontare il metro precedentemente inserito, stringere con forza la vite del piede.
Ripetere l'operazione per tutti i 4 piedi ciascuno in una cava.

5 Nm

K1

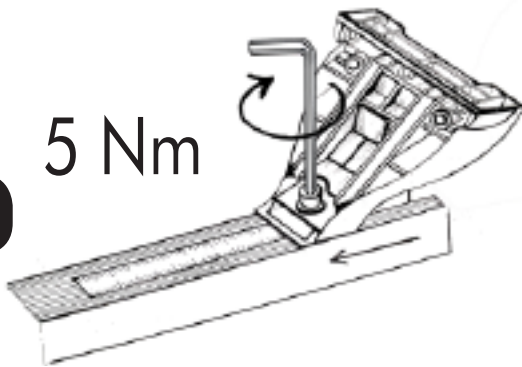

5 Nm

K1pro

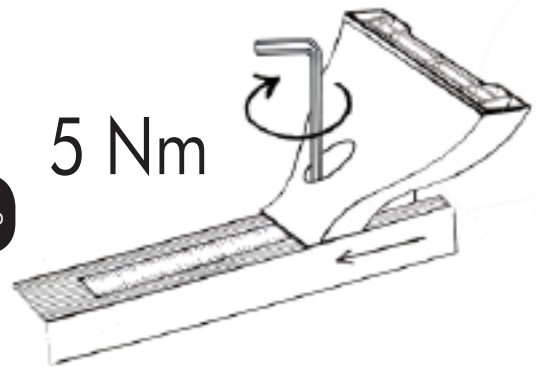
**4**

M1b - M2b

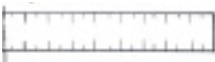

Inserire l'avanzo del metro tagliato (M1b per la barra anteriore ed M2b per la barra posteriore) per coprire la cava scoperta.

Ripetere l'operazione per tutte e 2 le barre.
Inserire, infine, i 4 tappi come indicato in figura.

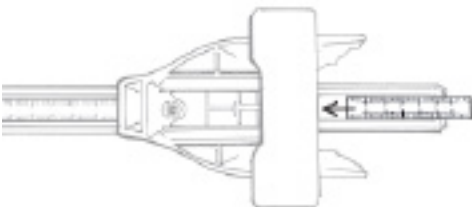

5



6

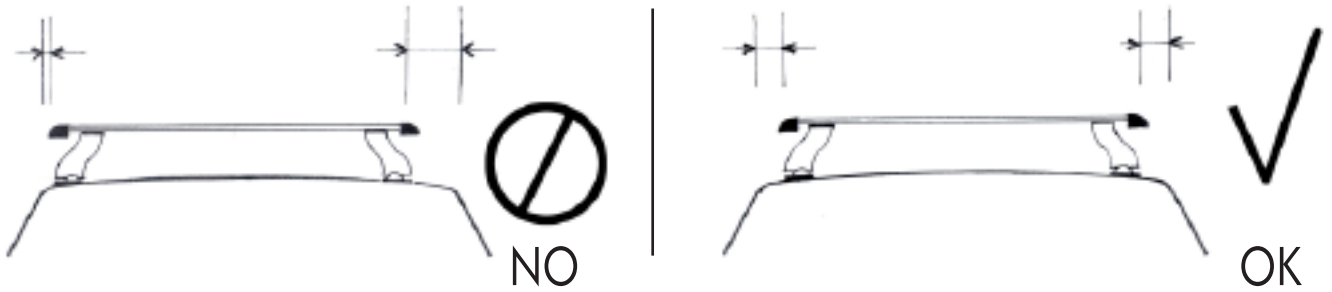

7

4 x
8x50

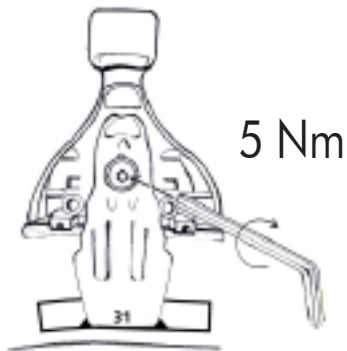

5 Nm

Stringere con forza la vite facendo **ATTENZIONE** a non spostare la centratura delle barre. Per ottenere il risultato corretto stringere le viti alternando il lato destro al lato sinistro in maniera uniforme.

8a



K1



x 4

8b



K1pro





x 4

MAX
55 kg

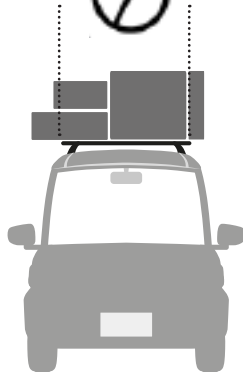

 NO



 OK

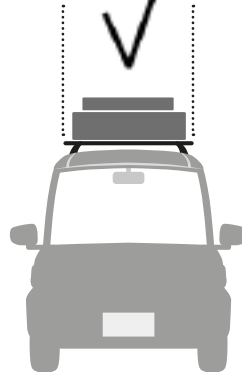

 NO

