

CASA AUTO	MODELLO	PORTE	ANNO
DACIA	Sandero	5	20>
RENAULT	Megane E-Tech	5	22>

M1	M2
8,9	7,5
8	6,6

G1	F1	G2	F2
38	1 foro A	38	1 foro A
38	1 foro A	38	1 foro A

T1	T2
X	X
X	X

Le tabelle di applicabilità sono soggette ad invecchiamento e/o modifiche, in caso di dubbio si consiglia di consultare il sito [www.k39.it](http://www.k39.it) costantemente aggiornato.  
The applicability tables are subject to aging and/or changes, in case of doubt it is advisable to consult the constantly updated website [www.k39.it](http://www.k39.it).



GUARDA  
IL  
VIDEO



WATCH  
THE  
VIDEO

X = predisposizione originale  
X =

1



Tab. 1:  
M1  
M2

4 x

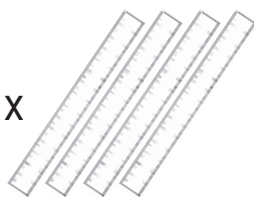

2 x M1

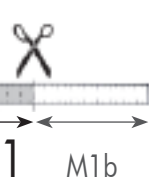

2 x M2

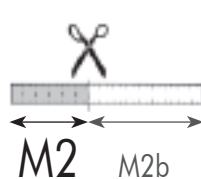

Tagliare i 4 metri in dotazione alla misura M1 ed M2 riportate in tabella

2

2 x



M1 - M2

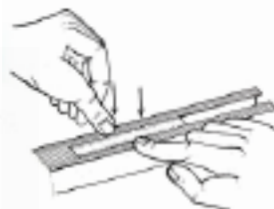
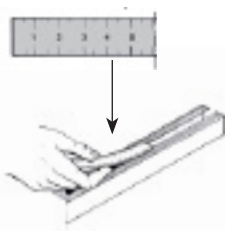

Inserire il metro tagliato in misura M1 nelle 2 cava della barra anteriore, portandolo fine a fine corsa. Ripetere l'operazione per la barra posteriore con i metri tagliati in misura M2.

3

4 x

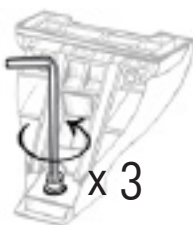

x 3

Prendere i 4 piedi dalla scatola, allentare la vite affinché i piedi possano entrare nella cava. Prendere il primo piede ed inserirlo in cava facendo ATTENZIONE a non sormontare il metro precedentemente inserito, stringere con forza la vite del piede.

Ripetere l'operazione per tutti i 4 piedi ciascuno in una cava.

5 Nm

K1

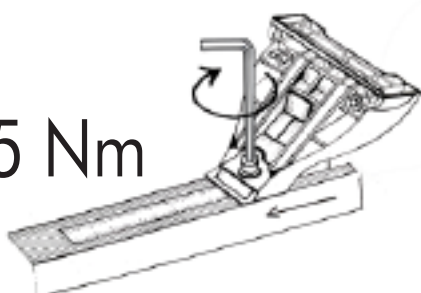

5 Nm

K1pro

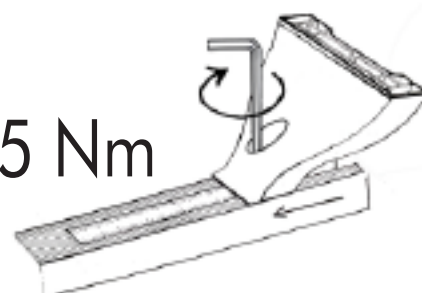

4

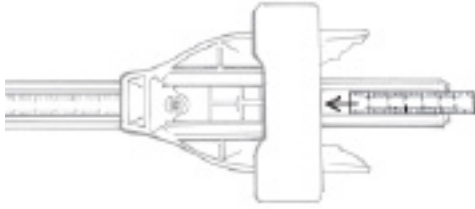
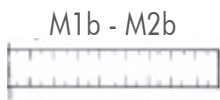

Inserire l'avanzo del metro tagliato (M1b per la barra anteriore ed M2b per la barra posteriore) per coprire la cava scoperta.  
Ripetere l'operazione per tutte e 2 le barre.  
Inserire, infine, i 4 tappi come indicato in figura.

5



Tab. 1:  
G1-F1  
G2-F2

4 x



8x14

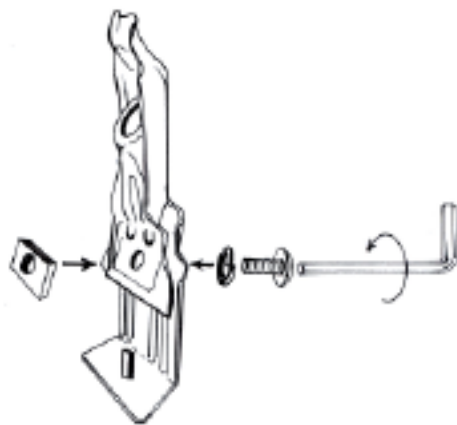

Assemblare le 4 GANASCINE come mostrato in figura, facendo **ATTENZIONE** a rispettare le misure riportate in tabella.  
Lasciare la parte inferiore della ganascina lasca.

6

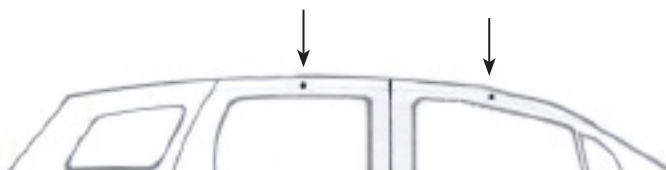

**ATTENZIONE:** utilizzare i fori interni della predisposizione originale, dopo aver rimosso i tappi in plastica.

7

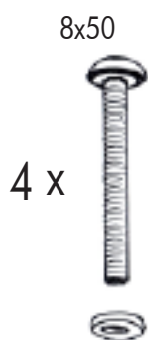

Posizionare la barra anteriore e la barra posteriore sul tetto dell'autovettura. Fissare le ganascine ai 4 piedi facendo **ATTENZIONE** a non stringere completamente la vite.

8

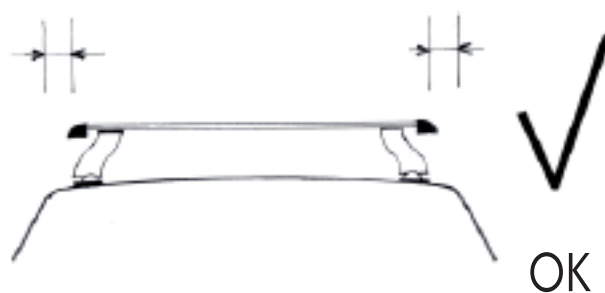
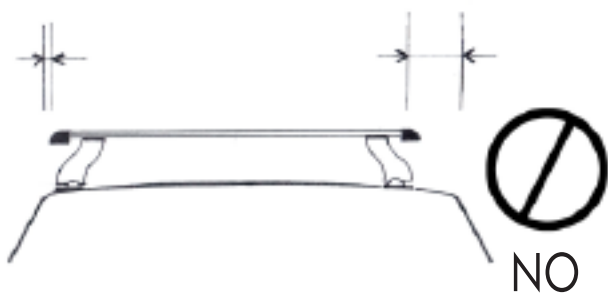

9

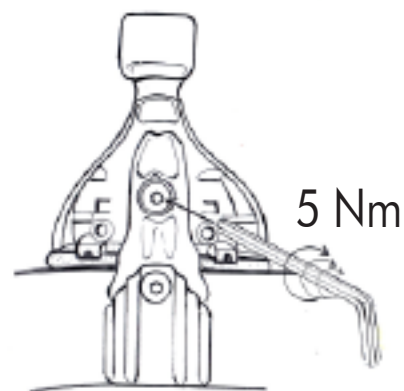
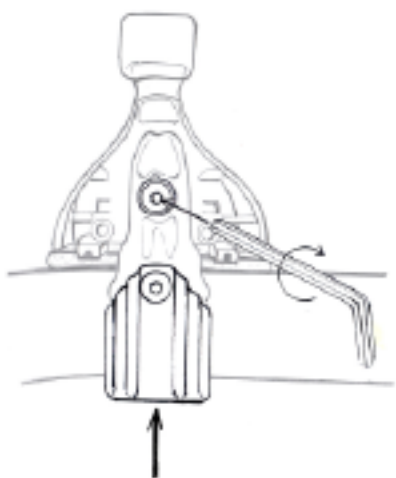

Stringere la vite superiore fino ad accompagnare la parte inferiore della ganascina al tetto. Stringere con forza la vite inferiore. Stringere con forza la vite superiore facendo **ATTENZIONE** a non spostare la centratura delle barre. Per ottenere il risultato corretto stringere le viti alternando il lato destro al lato sinistro in maniera uniforme.

9a



K1



x 4

9b



K1pro



x 4

MAX  
55 kg



NO

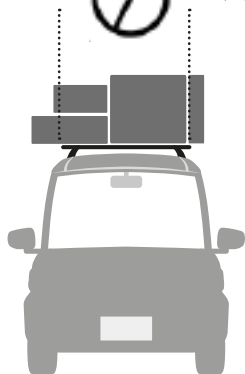

OK

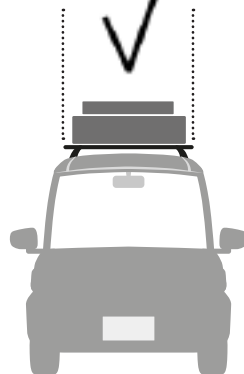

NO

