

	X 4		X 8
	X 4		X 16
	X 8		X 8
	X 1		X 8
	X 1		X 4
	X 4		X 4
	X 4		

	X 4		X 4
	X 4		X 4
		X 2	

				M1	M2
CITROEN	C6	4	04>12	10	6,5
PEUGEOT	308	5	07>14	12,6	8,4
PEUGEOT	407	4	04>12	9,4	6,9
PEUGEOT	3008	5	09>16	8,4	5,3
PEUGEOT	5008 mod base	5	09>17	8,1	5,9

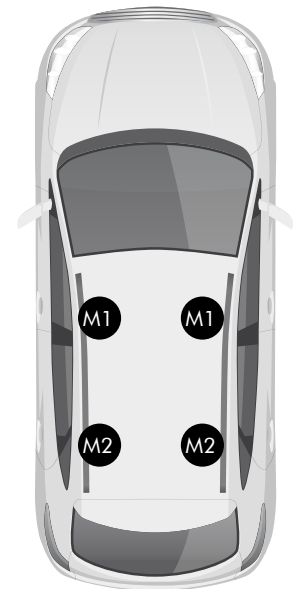

Le tabelle di applicabilità sono soggette ad invecchiamento e/o modifiche, in caso di dubbio si consiglia di consultare il sito [www.k39.it](http://www.k39.it) costantemente aggiornato.  
 The applicability tables are subject to aging and/or changes, in case of doubt it is advisable to consult the constantly updated website [www.k39.it](http://www.k39.it).

**1a** 4 x

**Clik!**

K1 MEDIUM  
K1 PRO  
K1 PRO ALU

**1b** 4 x

K1  
K1 MEDIUM  
K1 PRO  
K1 PRO ALU

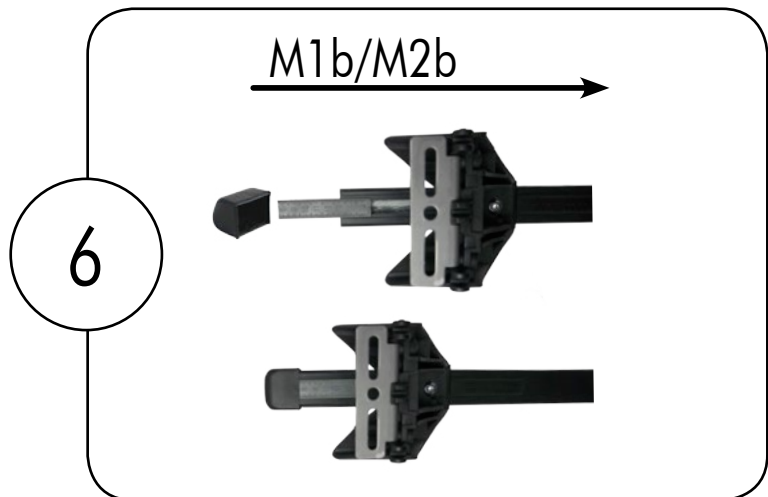
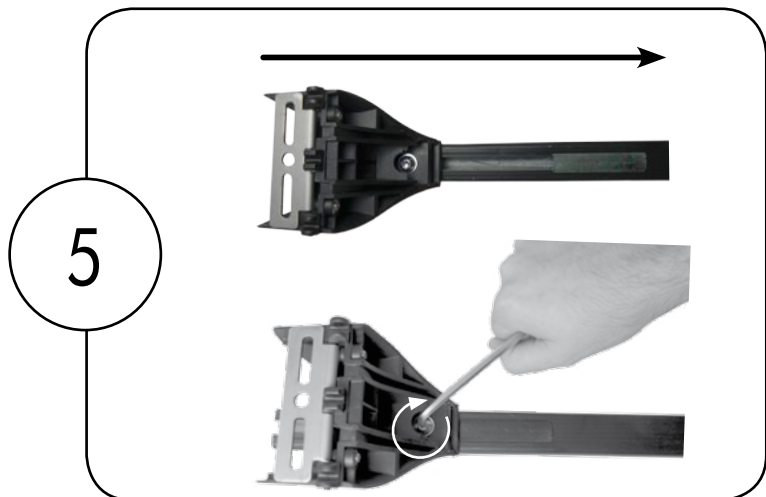
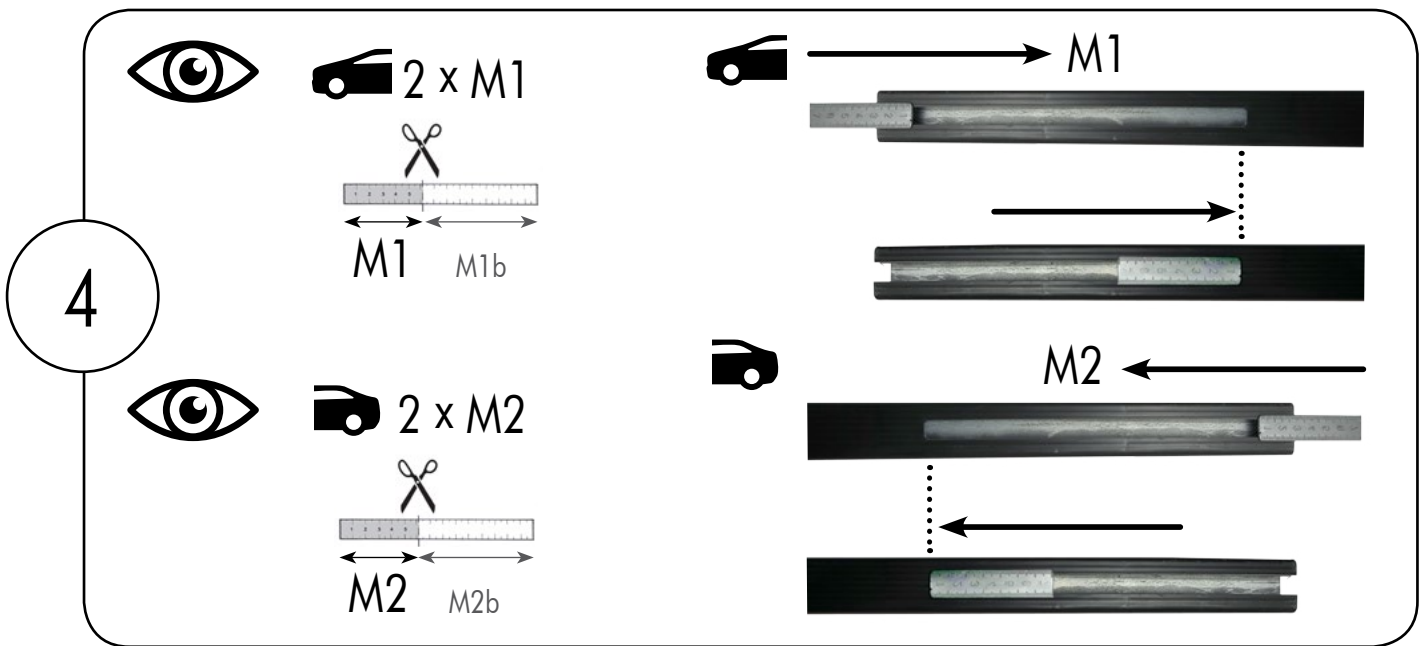
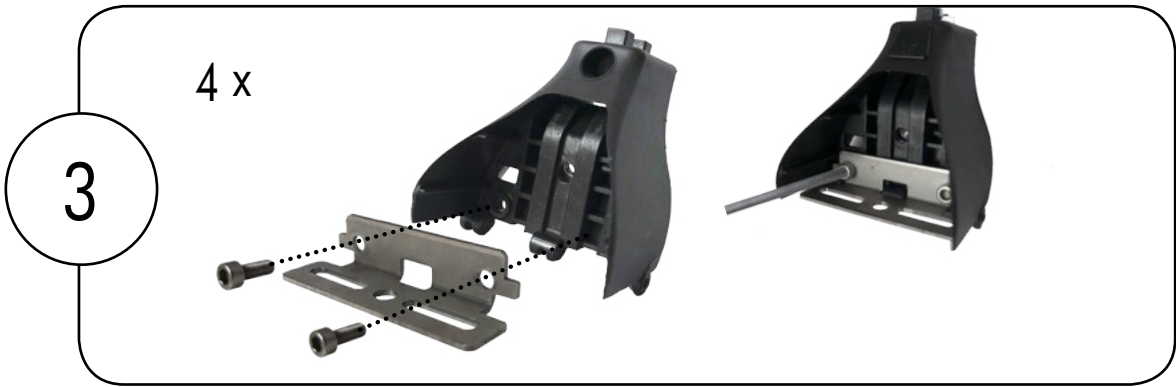
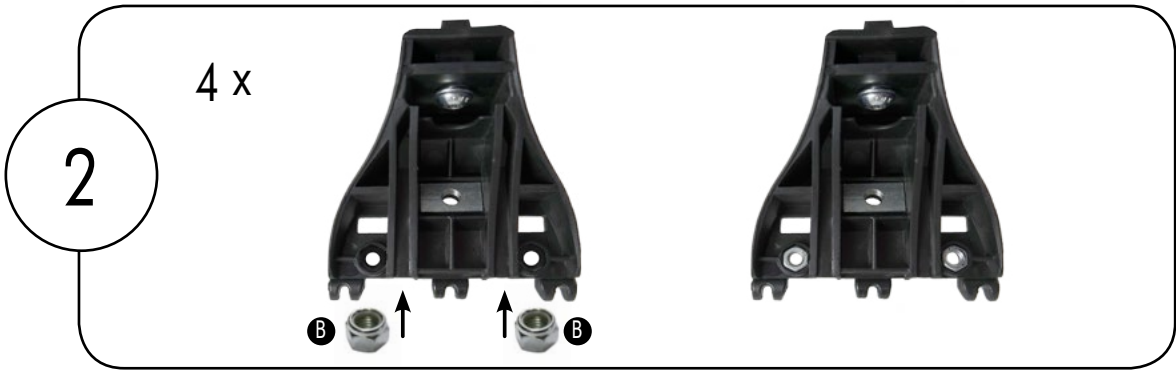

7

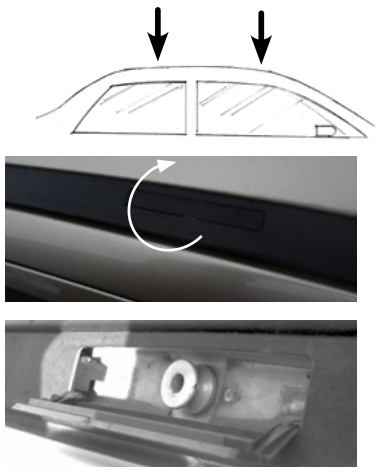

8



9

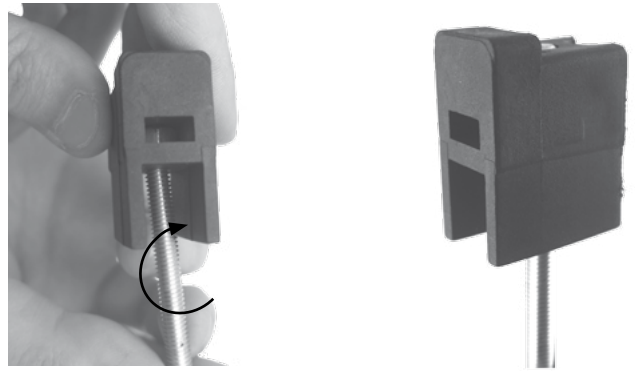
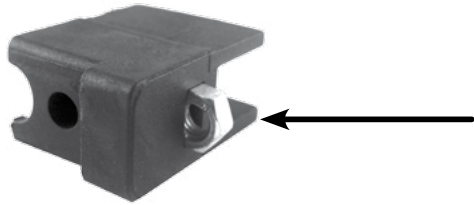
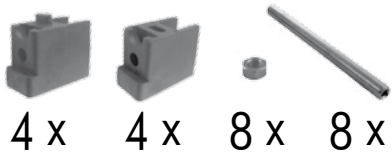

10

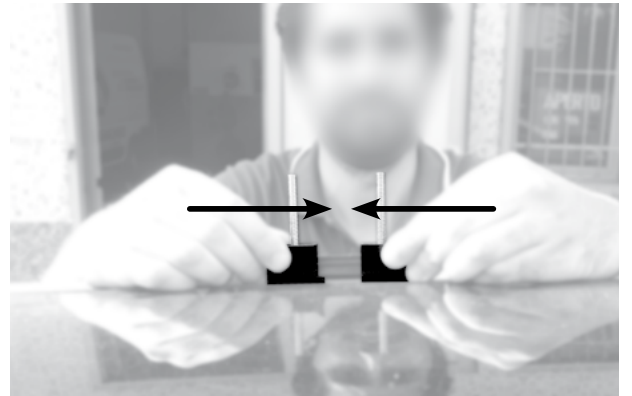

11

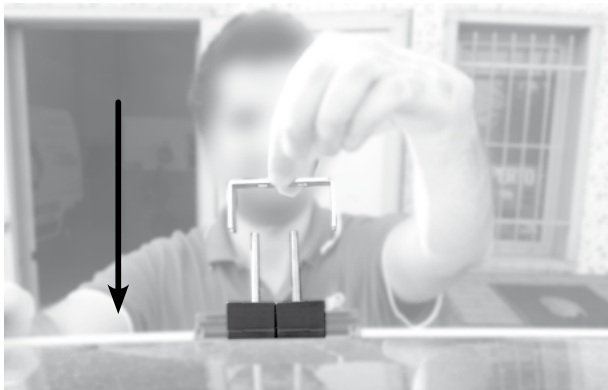

12

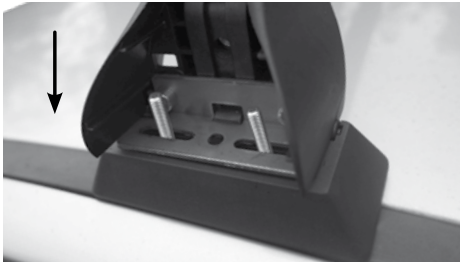
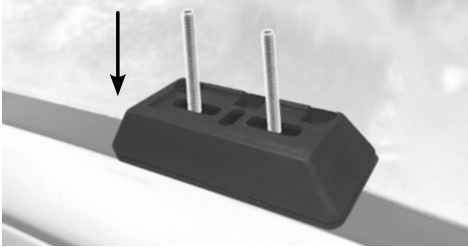
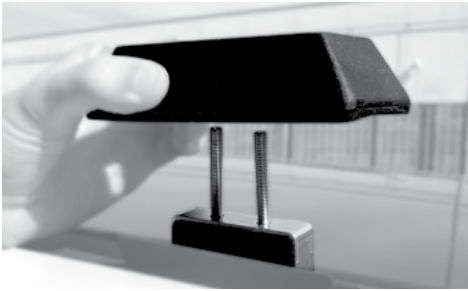

13

X 4

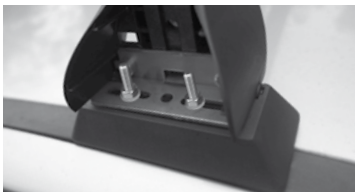

14

K1



K1 MEDIUM  
K1 PRO  
K1 PRO ALU

MAX  
75 kg



NO

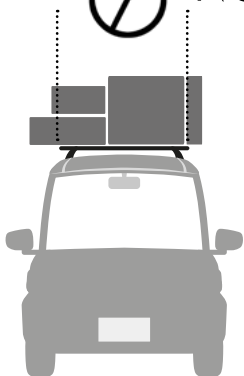

OK

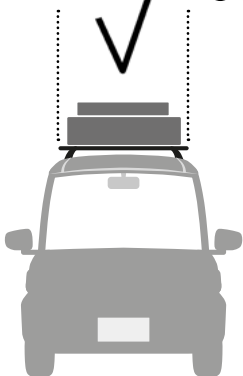

NO

